

Gas condensing hybrid system, output range: 17 kW and 24 kW

# Logamax plus GBH172iT

**Buderus**

Heating systems  
with a future.





# Eco-friendly hybrid solution.

The 2030 climate targets incorporate the most important legal guidelines aimed at dramatically reducing CO<sub>2</sub> emissions, including in the building sector. This is why heating systems running on renewable energies are becoming increasingly significant both for existing stock and new builds. When it comes to developing new, energy-efficient heating system solutions, Buderus is always one step ahead – as demonstrated by their “gas condensing hybrid systems”. The Logamax plus GBH172iT uses gas and solar energy or other renewable energies intelligently to make efficient use of the benefits of each energy source. This dramatically reduces the volume of CO<sub>2</sub> emissions. And since this helps towards the fulfilment of the climate targets, the Logamax plus GBH172iT is also eligible for government subsidies.

## Contents

2	General
4	Subsidy
6	Modern hybrid system
8	Buderus packages
10	Connectivity
11	System-Plus
12	Engineering in detail
14	Technical data



## Climate protection is worth it.

Renewable heating systems are subsidised by the government. We can advise you.

**0800 0 2030 00**

[www.buderus.de/beg](http://www.buderus.de/beg)



### Expert information.

In these dark grey boxes, you will find further in-depth information and factual summaries. This will give you the most important technical details at a glance.



**Logamax plus GBH172iT with buffer cylinder.**  
Thanks to the integrated hybrid mixing valve and a buffer cylinder depending on application, different system combinations can be conveniently implemented.

**Subsidy calculation example:**

Gas condensing hybrid system with buffer and DHW cylinder as well as solar thermal system for central heating backup with assembly and disposal of old system and creation of gas connection:

**Investment sum:**

**€27,000**

**Subsidy<sup>1</sup>:**

- 30 % gas hybrid heating
- 10 % oil replacement premium
- 5 % indiv. renovation roadmap (IRR)

■ **45 % government subsidy:**

**€12,150**

# The all-rounder among gas condensing hybrids.

The Logamax plus GBH172iT combines a boiler and a DHW cylinder in one unit, and offers a great heat and DHW convenience function in single-family or two-family homes. It is available in the outputs 17 kW and 24 kW, its domestic hot water output is 30 kW each.

**High CO<sub>2</sub> and energy cost savings thanks to the perfect integration of renewable energies.**

Never before has investment in a new, future-proof heating system been so worthwhile as now. Even alone, modern wall mounted condensing boilers from Buderus ensure that a great deal of climate objectives are achieved. If they are then combined with solar heat, stove or heat pump, they are especially efficient. As with Logamax plus GBH172iT: The gas condensing hybrid system emerges from the integrated hybrid mixing valve. This also reduces the effort required for installation and sources of faults to a minimum. The hybrid heating system is also suitable for liquid gas.

**Pioneering and renewable: Logamax plus GBH172iT.**

With Logamax plus GBH172iT, numerous system combinations are possible with different Logalux buffer cylinders in various convenient versions. For example, renewable support of room heating and domestic hot water heating by solar energy and biomass (e.g. pellet stoves/stoves).



### Many subsidy options.

A great advantage in terms of convenience is the gas hybrid heating subsidy of 30 %<sup>1</sup>. Merely replacing an old oil boiler adds 10 %<sup>2</sup> – and if there is a subsidised individual renovation roadmap, another 5 %<sup>3</sup>. So a subsidy of up to 45 %<sup>1,2,3</sup> is therefore possible for the Logamax plus GBH172iT as part of the federal subsidy for efficient buildings (BEG). You can find out about the individual subsidies on our website at [www.buderus.de/geg](http://www.buderus.de/geg).

### The Buderus advice hotline.

Buderus offers you appropriate products and systems for the hybrid system solution, which will preferably be subsidised in future by the BEG. The free Buderus advice hotline informs you of the optimal heating system solution for every application, the maximum subsidy and controls of climate protection at the phone number:

**+49 (0) 800 0 2030 00 (Monday to Friday, 7 o'clock in the morning to 7 o'clock at night).**

### Buderus is BEG ready.

Today, Buderus already records the quantities of heat and the energy consumption and efficiency display required as part of the BEG individual measures from 2023, and allows the customer to monitor their consumption and optimise it. Buderus is therefore BEG ready.



<sup>1</sup> The named subsidy values refer as a proportion to the gross investment costs, incl. VAT, for the new heating system (wall mounted boiler, assembly, additional services, etc.).

<sup>2</sup> 10 % subsidy for replacing an oil boiler.

<sup>3</sup> Of this, 5 % subsidy for a fully available and subsidised individual renovation roadmap.



**Maximum ease of maintenance and smart construction.**

The insulation from the plate heat exchanger can be used directly as a collector trough for residual water.



**Connections of gas, water and heating horizontally left/right. Buffer cylinder connection laterally left/right possible.**



**Vertical connection options: Gas, water and heating vertical, buffer cylinder lateral, left/right.**

# The latest engineering: Gas condensing hybrid system.

With hybrid systems, the use of two energy sources is optimally combined. A renewable source, consisting of sun, wood or environmental heat, that reduces costs and CO<sub>2</sub>, and the fossil source of gas, that is always available and reliably covers the remaining demand and ensures a maximum DHW convenience function, if the renewable source currently supplies no or too little energy. The Logamax plus GBH172iT gas condensing boiler in two outputs of 17 kW and 24 kW forms the basis for the hybrid system. With the integrated 100 litre stratification cylinder and the domestic hot water output of 30 kW, a maximum DHW convenience function is ensured.

## **Efficiency in the system.**

Thanks to the integrated hybrid mixing valve, there is no storage of fossil energy (generated by gas condensing boiler) in the buffer cylinder. In contrast to most market-standard systems, only renewable energy from solar radiation or pellet stove/stove is stored here in the buffer – for free and with a considerable efficiency advantage compared with a standard combination storage solution.



Integrated hybrid mixing valve



Opened Logamax plus GBH172iT

# Appropriate systems entirely as required.

Various buffer cylinder solutions allow different system integrations of a solar thermal system, a pellet stove/stove or a heat pump. With the hybrid box including HM200 hybrid module, a heat pump without additional indoor unit can be integrated. The perfect solution is combination with a photovoltaic system, since the current is thermally stored in the buffer cylinder. As a system expert, Buderus therefore offers exactly the right system solution for every need.

## The Buderus Logamax plus GBH172iT Logasys packages:

- The Buderus basic system offers the best price-performance ratio and is suitable for combination with a solar thermal system (up to four Logasol SKN 4.0/SKT 1.0 flat-plate solar collectors) with the solid Logalux PNS400 buffer cylinder
- You will enjoy additional convenience with the Buderus convenience system with solar power and/or a stove. The Logalux PNR500 or PNR750 buffer cylinder with temperature-sensitive return flow supply allows combination with a solar thermal system (up to five Logasol SKN 4.0/SKT 1.0 flat-plate solar collectors) and the integration of a stove
- With the premium system, an electrically operated WLW196i AR or WLW196i AR S+ heat pump external unit and the hybrid box can be integrated via the Logalux P200 heat pump buffer cylinder without additional indoor unit

## “Plug & Warm” – for significantly faster installation.

Complex engineering is not complicated at Buderus, but compact and easy to plan. Even the buffer cylinder can be connected directly and without further effort to the Logamax plus GBH172iT. Thanks to the integrated hybrid mixing valve, neither additional mixing valves and control elements nor – with a heating circuit – a low loss header or an external heating circuit set are required. The result is a highly compact design, significantly reduced effort required for installation and considerable minimisation of sources of faults.



## Uncomplicated integration of the heat pump.

The gas condensing hybrid system emerges with the new hybrid box incl. HM200 hybrid manager and the efficient Logatherm WLW196i AR heat pump external unit. The hybrid box can be installed especially easily and is the link between the floor standing gas condensing boiler and the heat pump external unit. No additional indoor unit of the heat pump is therefore required, as the collaboration between floor standing gas condensing boiler and heat pump controls the integrated HM200 hybrid manager.



**Even more flexible system integration.**

With all Buderus packages, the high modulation range in heating mode of 1 : 8 or in DHW mode of 1 : 10 ensures efficient operation of the gas condensing hybrid appliance. The already integrated 100 litre stratification cylinder and the high DHW output of 30 kW offer a maximum DHW convenience function. In addition, it achieves a very high efficiency class A+ (together with the Logamatic RC310 system operating unit) and a hot water efficiency up to A+++ (depending on system solution).



**Logamax plus GBH172iT**

**Buderus basic system with solar:**



**Logasol KS0110**

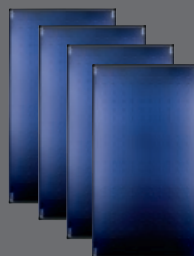

**Four flat-plate solar collectors  
Logasol SKN 4.0 / SKT 1.0**



**Logalux PNS400**

**Buderus convenience system with solar power and/or stove:**



**Logasol KS0110**



**Four or five  
flat-plate solar collectors  
Logasol SKN 4.0 / SKT 1.0**



**Logalux PNR500 /  
PNR750**



**Logastyle Lamina**

**Buderus premium system with air to water heat pump:**

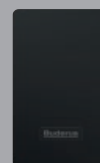

**Hybrid box incl.  
HM200 hybrid manager**



**WLW196i AR S+ heat pump**



**Logalux P200**



Logamatic RC310  
system operating unit



#### Buderus ConnectPRO.

The heating professional uses this to connect to the system and obtain detailed information about the system. They can make readjustments remotely, if required, and they know which spare parts are required on-site in the event of an incident.



Scan the QR code and download the Buderus MyDevice app:  
[qr.buderus.de/apps](http://qr.buderus.de/apps)

# Everything efficiently controlled.

The Logamatic EMS plus control system intelligently regulates your Buderus heating system, ensuring all components interact perfectly. All of the information necessary for optimal operation is directed to the control system from the heating appliance, DHW cylinder, solar thermal system and the heated rooms themselves. This allows the Logamatic EMS plus control system to constantly register how much energy is currently required and to match the heating system output to the actual demand.

#### Intuitive menu navigation.

Convenient operation of your heating system, tailored to your particular needs, takes priority at Buderus. The Logamatic EMS plus control system supports this. That's why we have reduced the Logamatic RC310 system operating unit to a few, easy-to-use elements – of course with a full scope of function.

# How your heating system goes online.

The Buderus connectivity concept offers a wide range of connectivity options. For example, via the Internet with the Buderus apps, connection to modern Smart Home systems, or the universal KNX interface for integration into premium home automation systems.

All Buderus heating appliances with the Logamatic EMS plus control system and the Logamatic RC310 system operating unit can be combined in an interactive network – for improved service and exceptional heating comfort. The Internet interface ensures a simple and secure Internet connection via the Gateway Logamatic web KM200 accessory.



#### The MyBuderus app.

With Buderus, your heating goes mobile. The MyBuderus app allows you to control your heating system flexibly and on the go, from anywhere and totally intuitively on a smartphone or tablet. Optimise your energy consumption and access your heating system at any time and from anywhere. You can operate and monitor your heating system from wherever you are and adjust the heating functions conveniently to suit your requirements. When given access, your heating contractor can use Buderus ConnectPro to remotely check system operation and make small adjustments.

# The System-Plus.

We are the system experts. We impress our clients with our perfectly synchronized components. Our sustainable system solutions are solid, modular and connected – and tailored to your individual requirements.

## Logamax plus GBH172iT

### Logastyle Lamina



### Logatherm WLW196i AR S+



### Logasol SKT 1.0

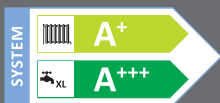

A+++ → G

The rating shows the energy efficiency of the system with Logasys SL130 system solution with Logamax plus GBH172i-17 T100 S and Logamatic RC310 system operating unit, as well as PNS400 buffer cylinders and 4x Logasol SKN 4.0. The rating may vary depending on the components or output size.



We are so convinced of the exceptional quality of our system solutions that we provide a 5-year system warranty on all Buderus Logasys systems and Logaplus packages. Your heating contractor will provide you with your personal warranty certificate along with all the information you need about system energy efficiency according to the EU directive.

For more information and system warranty conditions, contact your heating contractor or go to [www.buderus.de/systemgarantie](http://www.buderus.de/systemgarantie)

# Technology in detail.

**Shared appliance cover**  
for convenient and fast maintenance.

**Large warm water heat exchanger**  
for efficient domestic hot water heating  
with renewable energy sources.

**Intelligent assembly concept**  
for assembly and maintenance  
as simple as can be.



**Heat exchanger assembly with modulation up to 1:10**  
Energy-efficient operation mode by optimal power adjustment to need.

**Hybrid mixing valve**  
for efficient integration of renewable energy sources into the heating system.

**High-efficiency pump**  
of variable speed for high energy efficiency and significantly reduced electricity costs.

**Logamatic RC310 system operating unit**  
with energy consumption and efficiency display for optimal control of the entire system.

### Buderus basic system with solar:

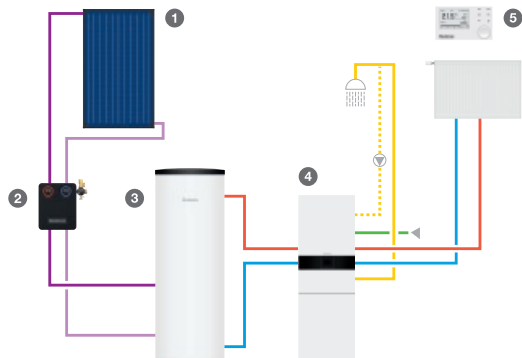

- ① Logasol SKN 4.0 flat-plate solar collector
- ② Logasol KS0110 SM100/2 solar pump station
- ③ Logalux PNS400/5 buffer cylinder
- ④ Logamax plus GBH172iT
- ⑤ Logamatic EMS plus with Logamatic RC310 system operating unit

### Buderus convenience system with solar power and stove:

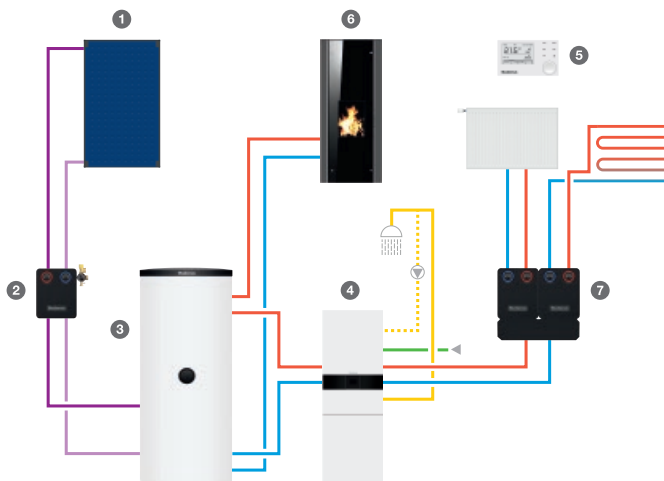

- ① Logasol SKT 1.0 flat-plate solar collector
- ② Logasol KS0110 SM100/2 solar pump station
- ③ Logalux PNR500 EW-C or PNR750 EW-C buffer cylinder
- ④ Logamax plus GBH172iT
- ⑤ Logamatic EMS plus with Logamatic RC310 system operating unit
- ⑥ Logastyle Lamina pellet stove/stove
- ⑦ Buderus low loss header with heating circuit sets

### Buderus premium system with air to water heat pump:

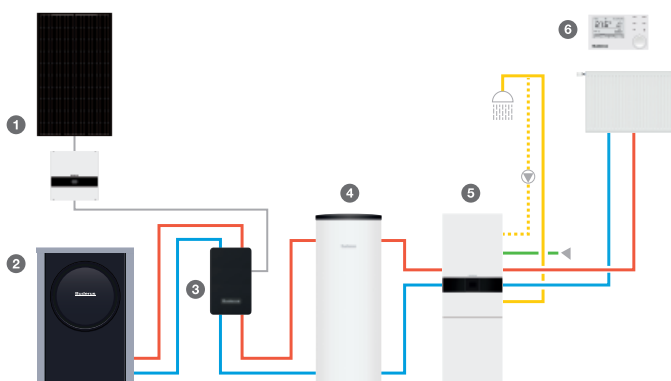

- ① Photovoltaic system incl. inverter
- ② Logatherm WLW196i.2 AR S+ outdoor unit
- ③ Hybrid box incl. HM200 hybrid manager
- ④ Logalux P200 buffer cylinder
- ⑤ Logamax plus GBH172iT
- ⑥ Logamatic EMS plus with Logamatic RC310 system operating unit

# Technical data.

Logamax plus GBH172iT		GBH172i-17 T100S	GBH172i-24 T100S
Rated output (80/60 °C)	kW	3.0–16.6	3.0–23.8
Rated output (50/30 °C)	kW	3.4–17.8	3.4–25.3
Rated output (domestic hot water)	kW	30.0	30.0
Charging principle Domestic hot water		SLS (Stratification cylinder)	SLS (Stratification cylinder)
Cylinder content	l	100	100
Rating code at flow temperature = 75 °C, DIN 4708	Nominal output figure	2.8	2.8
Energy efficiency class		A	A
Energy efficiency class spectrum		A+++ → D	A+++ → D
Room heating energy efficiency	%	94	94
Class for the water heating energy efficiency (XL)		A	A
Energy efficiency class spectrum		A+ → F	A+ → F
Domestic hot water efficiency	%	85	85
<b>Dimensions</b>			
Height	mm	1,531	1,531
Width	mm	600	600
Depth	mm	670	670
Weight	kg	116	116
Flue gas pipe diameter	mm	80/125	80/125

Logalux		PNS400/5
Useful capacity (total)	l	390
Height	mm	2,100
Tilt height	mm	1,965
Connections		793–1,278
Heating water connection dimension	DN	R1"
Boiler return connection dimension	DN	R1"
Empty weight (without packaging)	kg	110

The dimensions in the table refer to the actual product dimensions.

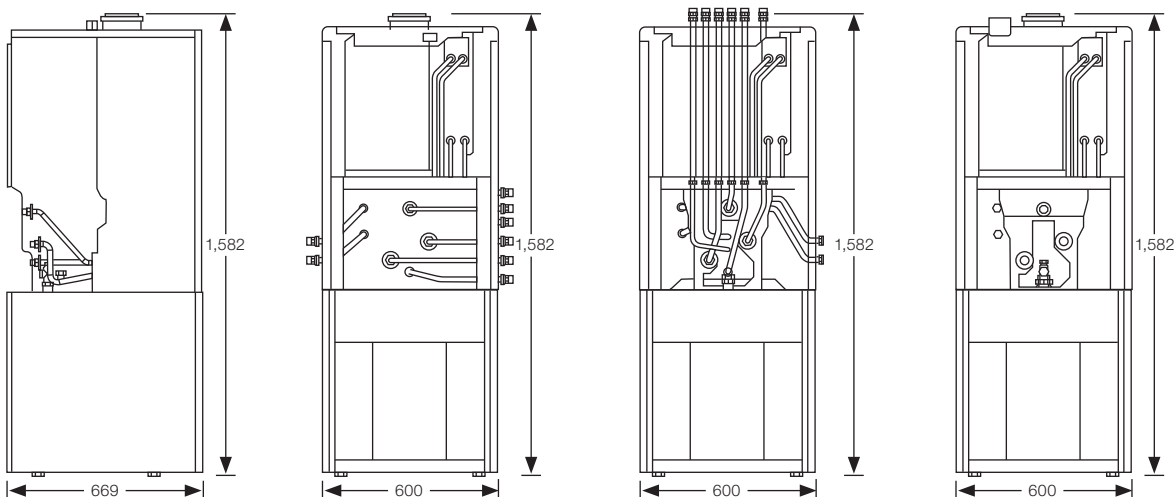

# Benefits at a glance:

- Modern gas condensing hybrid system for maximum CO<sub>2</sub> and energy cost saving
- System solutions incl. five year system guarantee depending on application: Integration of a solar thermal system, a pellet stove/stove or an air to water heat pump
- High subsidy up to 45 % (incl. 10 % oil replacement premium and 5 % for available and subsidised indiv. renovation roadmap)
- Integrated hybrid mixing valve for reduced effort required for installation and minimum sources of faults
- Combination of heating boiler and DHW cylinder in the smallest space
- Suitable for liquid gas
- Great DHW convenience function thanks to 100 litre stratification cylinder and high domestic hot water output
- Quick to assemble and install

## Climate protection is worth it.

As part of the climate targets, renewable heating systems such as heat pumps are subsidised by the state. Buderus advises and supports you in this.

Our free advice hotline:  
Monday to Friday, 7 o'clock in the morning to 7 o'clock at night

**0800 0 2030 00**

[www.buderus.de/beg](http://www.buderus.de/beg)



\* In relation to the eligible gross investment costs. Incl. 10 % oil replacement premium and 5 % subsidy for a complete and subsidised IRR.

## Heating systems with a future.

As experts for system solutions, we have been developing top-of-the-range products since 1731. Regardless of whether operation is renewables-based or conventional, our heating systems are solid, modular, connected – and everything is perfectly synchronized. This makes us pioneers in the field of heating technology. We place value on comprehensive yet individual advice and ensure tailor-made, sustainable solutions through the extensive service we offer.

**Buderus**

Bosch Thermotechnik GmbH  
Buderus Marketing International  
D-35573 Wetzlar, Germany

**Buderus**

Heating systems  
with a future.

**Customer hotline**

Telephone: +00 (0)0000 000-0

Fax: +00 (0)0000 0000

[info@buderus.land](mailto:info@buderus.land)



**Find a retailer**

[www.buderus-haendlersuche.land](http://www.buderus-haendlersuche.land)



**Facebook**

[facebook.com/buderus](https://facebook.com/buderus)



**Twitter**

[twitter.com/buderus](https://twitter.com/buderus)



**YouTube Channel**

[youtube.com/buderus](https://youtube.com/buderus)

[www.buderus.land](http://www.buderus.land)

QR-Code